

# MERCEDES BENZ – 3500 MOTOR OM 311

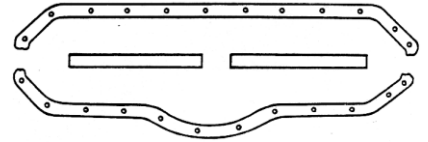
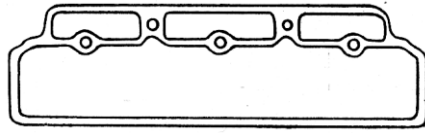
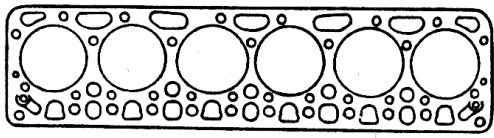

4585

4545

4577

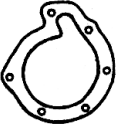
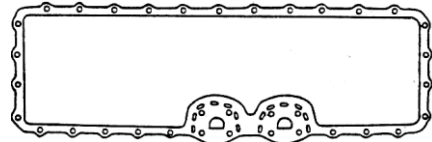
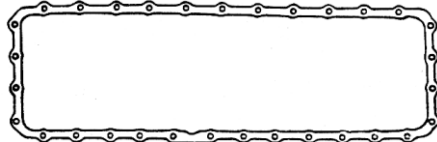
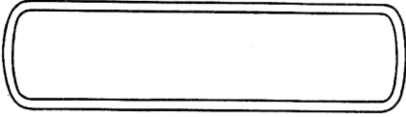

4590

4501

4501

4505

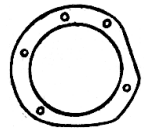
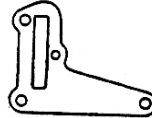
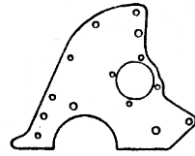
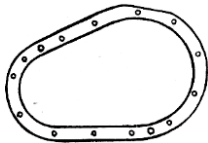
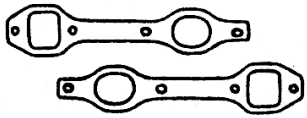

4502

4570

4571

4573

4510

4501

4520

4572

# MERCEDES BENZ – 1112

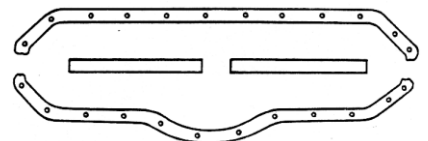
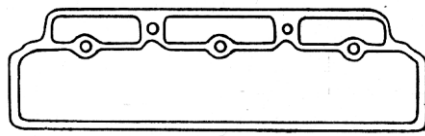
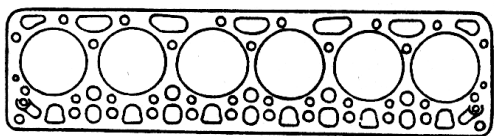

4585

4545

4577

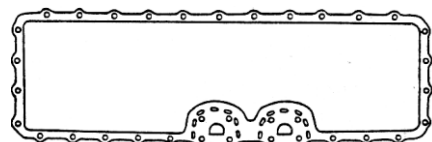
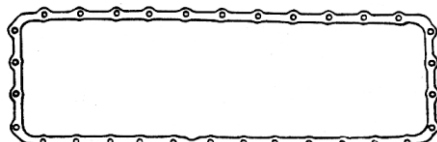
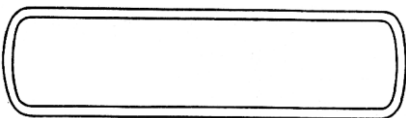

4590

4501

4501

4505

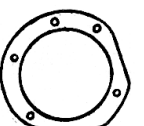
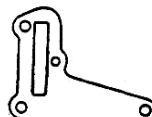
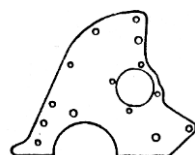
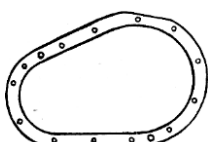
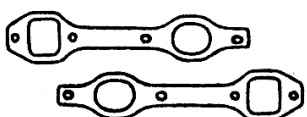

4502

4570

4571

4573

4510

4501

4520

# MERCEDES BENZ — 1114 MOTOR OM 352

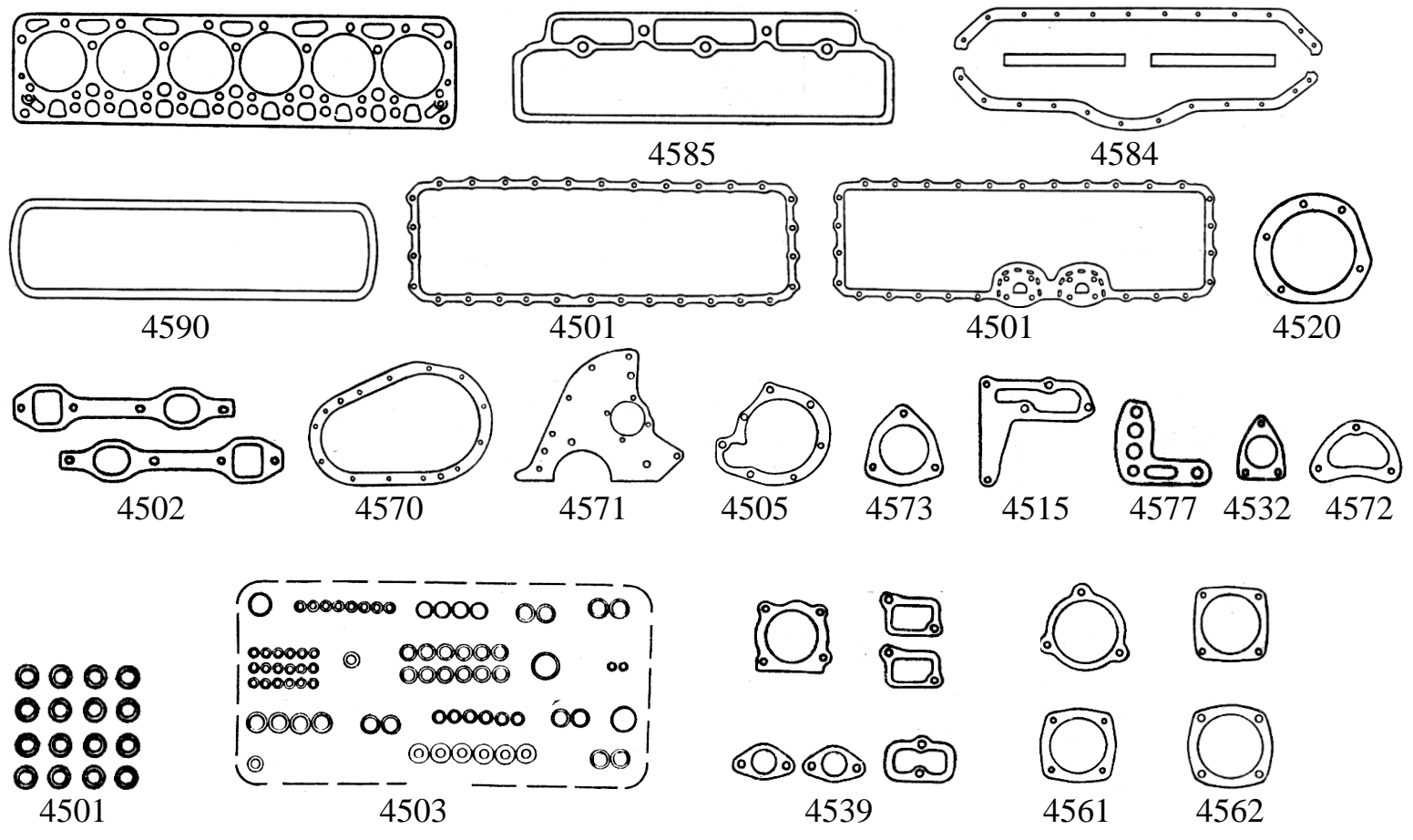

# MERCEDES BENZ — 1517 TURBO MOTOR OM 352 A

